

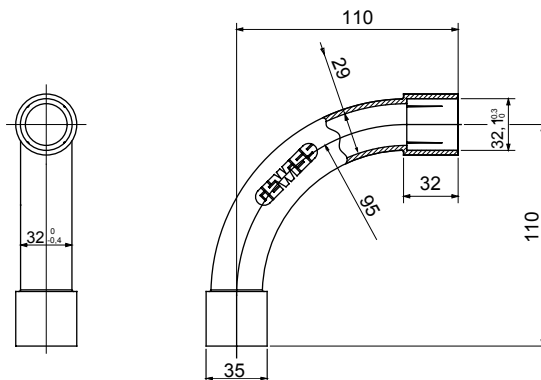

Nyomvonalai alkatrészek IP40 és IP67 védelemmel rendelkező merev védőcsövekhez.

Szín	Szürke RAL 7035	IP védelem szintje	IP40
Védőcső Ø (mm)	32	Alapanyag típusa	Halogénmentes az EN 50642 szabvány szerint
Elektronikai kód	21221		

DIMENSIONAL



TECHNICAL SYMBOLOGY

IP

HF
HALOGEN FREE

IP40

STANDARDS/APPROVALS

