

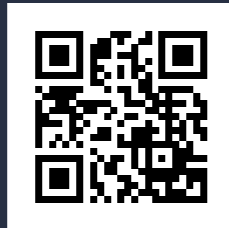

MOUNTKIT
by
ENERACK

Become our partner



mountkit.eu
info@mountkit.eu

Official Distributor



shop.solar-kit.eu



MOUNTKIT
by
ENERACK

PROFESSIONAL SOLAR MOUNTING SYSTEM PRODUCT CATALOG



ISO 9001: 2015 quality management system certified

THE BACKBONE OF THE SOLAR PANEL SYSTEM

We know how important it is for the backbone of a solar system to be quick and easy to install, durable and last but not least, outstanding value for money. That's why we have created the Mountkit by Enerack range of mounting brackets for all roof surfaces!



Outstanding value for money



Lightning fast and easy assembly



Durable, stable construction



Permanent stock with CE and TÜV certification



Long life - 10 years warranty



Prepared for easy assembly



Aluminium quality certificate

TILE ROOF

Mountkit offers a wide range of tile roof hooks that are compatible with various roof types:











- standard tile,
- flat tile,
- slate tile.

These hooks are designed with key specifications to reduce inventory costs and facilitate quick and easy installation. The innovative rail connect base-support design enhances product strength and ensures safe usage. With an extensive selection of roof hooks, Mountkit provides customers with multiple options and allows for customization to meet specific installation requirements.



TECHNICAL FEATURES	
Product name	Tile roof mounting system
Application	Tile roof, Flat tile roof, Slate roof
Inclination	Parallel to the roof
Material	AL 6005-T5, SUS 304
Finish	AL 6005-T5 Anodized, SUS 304 Shot blasting
Module orientation	Landscape or Portrait

TILE ROOF ATTACHMENT

<p>Item No. ERK-TRH-T01 Description Tile Roof Hook - Adjustable</p> 	<p>Item No. ERK-TRH-T06 Description Tile Roof Hook - Adjustable</p> 	<p>Item No. ERK-TRH-F01 Description Flat Tile Roof Hook</p> 
<p>Item No. ERK-TRH-T17 Description Tile Roof Hook</p> 	<p>Item No. ERK-TRH-T19 Description Tile Roof Hook</p> 	<p>Item No. ERK-RCN Description Standard Rail Clamp with ERK Nuts Kita</p> 
<p>Item No. ERK-R52 Description 52mm Rail</p> 	<p>Item No. ERK-R52L Description 52mm L Rail</p> 	
<p>Item No. ERK-AEC Description Universal Adjustable (30-40mm) End Clamp Kit</p> 	<p>Item No. ERK-EIC Description Universal Adjustable (30-40mm) Inner Clamp Kit (Include Spring & Earthing Clip)</p> 	

SHINGLE ROOF

Mountkit offers a diverse range of tile roof hooks compatible with various roof types, including asphalt shingle tile. Our uniquely designed mid and end clamps are suitable for solar modules with a thickness of 30-40mm. Incorporating major specifications, our design reduces inventory costs and facilitates quick and easy installation. The innovative rail connect base-support design significantly enhances product strength and ensures safe usage.

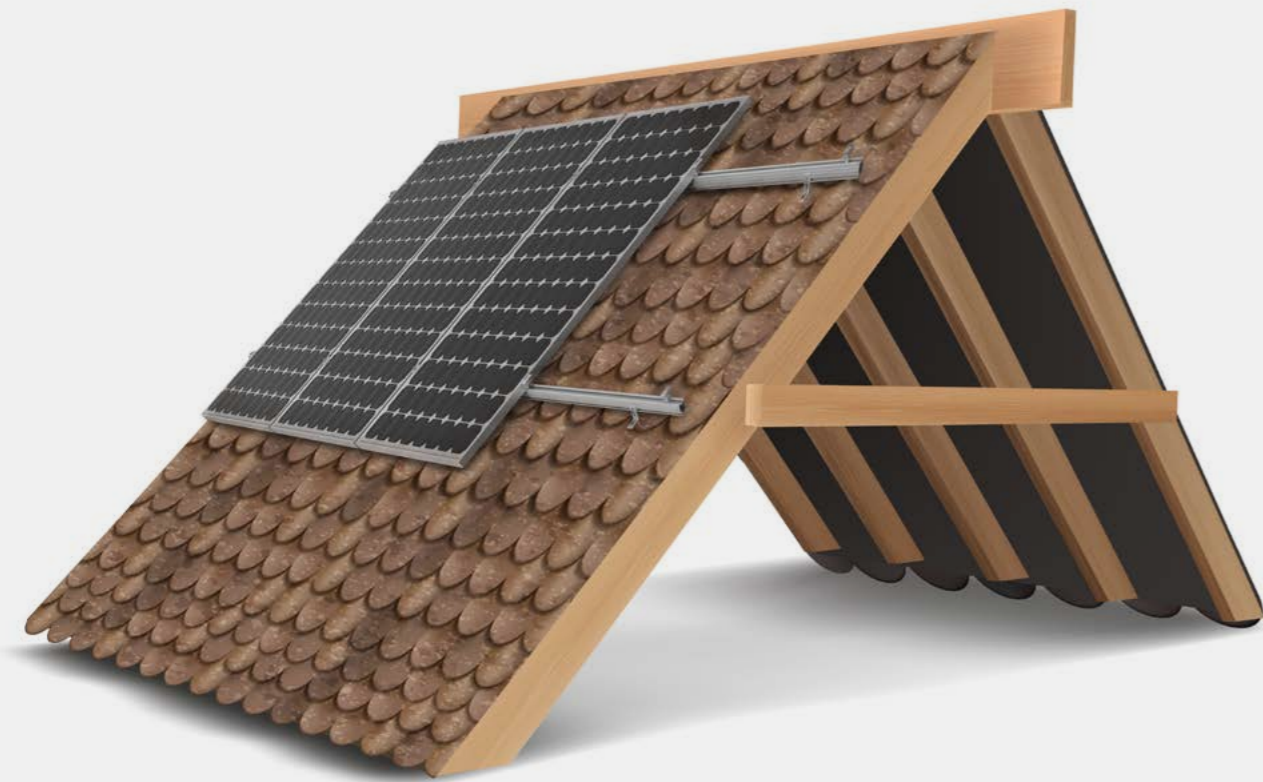

Item No. ERK-TRB-D10
Description 26mm Mini Rail for Corrugated or Trapezoidal Sheet Metal 1



Item No. ERK-R70
Description 70mm Rail 2



Item No. ERK-TRB-S01
Description Slate roof hook 3



Item No. ERK-TRB-D03
Description Hanger Bolt L Feet for Corrugated Fibre Cement (M10x200, M10x300) 4



Item No. ERK-TRB-D01
Description L Feet for Corrugated or Trapezoidal Sheet Metal 5



Item No. ERK-R52
Description 52mm Rail 6



Item No. ERK-R52L
Description 52mm L Rail 7



Item No. ERK-AEC
Description Universal Adjustable (30-40mm) End Clamp Kit 7



Item No. ERK-EIC
Description Universal Adjustable (30-40mm) Inner Clamp Kit (Include Spring & Earthing Clip) 8



METAL ROOF

Mountkit Tin roof systems offer two fixing methods:

1. Drilling solutions such as bracket L-feet, hanger bolts, and T type hooks.
2. Standing seam clamps for direct mounting without roof damage.

Our design, featuring key specifications, reduces inventory costs and ensures quick, easy installation. The innovative rail connect base-support enhances product strength and safety. Mountkit provides a wide variety of tin roof brackets, with customization available to meet specific installation needs.

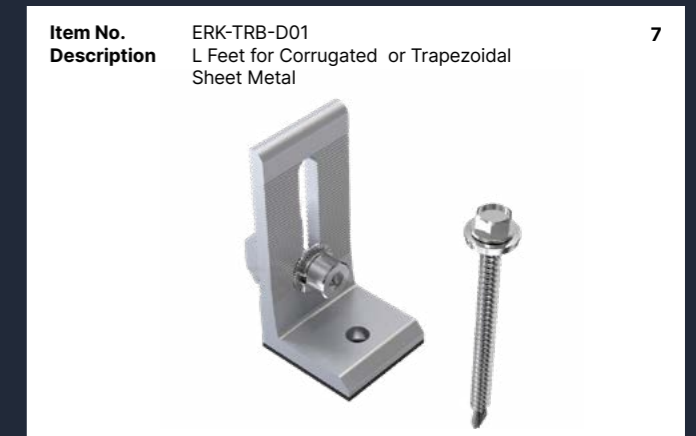
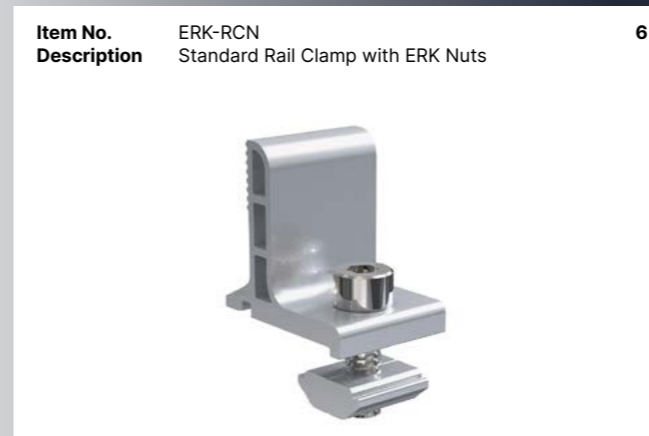
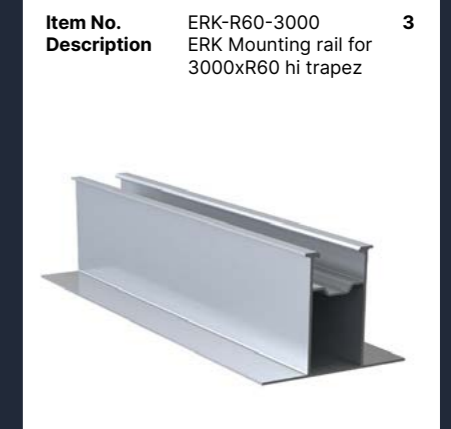
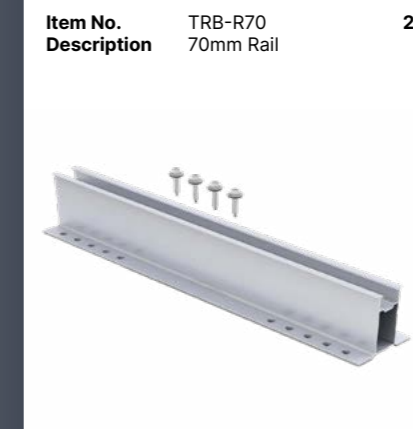
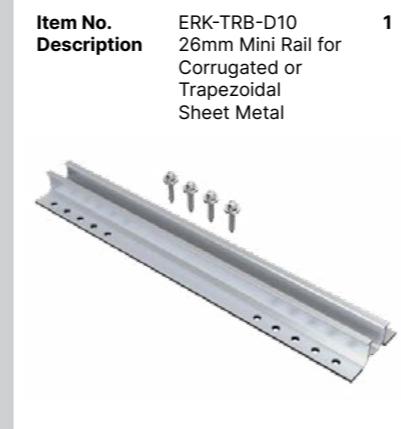
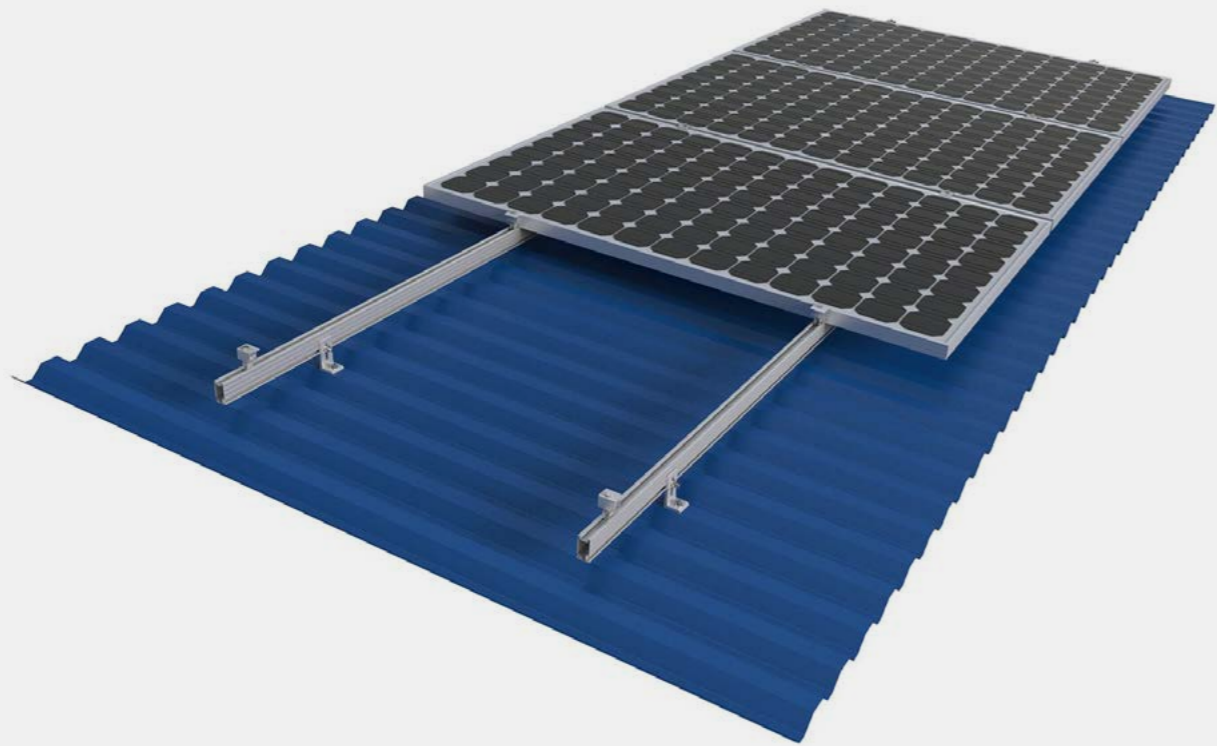

TECHNICAL FEATURES	
Product name	Metal roof mounting system
Application	Metal roof
Inclination	Parallel to the roof
Material	AL 6005-T5, SUS 304, EPDM
Finish	AL 6005-T5 Anodized, SUS 304 Shot blasting
Module orientation	Landscape or Portrait

BALLASTED-PRO MOUNTING

10 Degree dual tilt

E-W 10 is designed for solar installations on flat roofs, optimizing both roof space utilization and PV quantity installed to a maximum level. All components are made from extruded aluminum and fastened with stainless steel 304 hardware. EPDM foam tape is placed at the bottom of the system to separate it from the roof. The EPDM foam tape enhances friction and compensates for height differences when the roof is uneven. The same components can be utilized for a south-facing flat roof installation.



TECHNICAL FEATURES	
Product name	E-W 10 or 15
Application	Flat roof
Tilt	10°
System Material	Extruded aluminum profile 6005 T5
Fastener material	Stainless steel 304
Finish	Anodized
Module orientation	Landscape

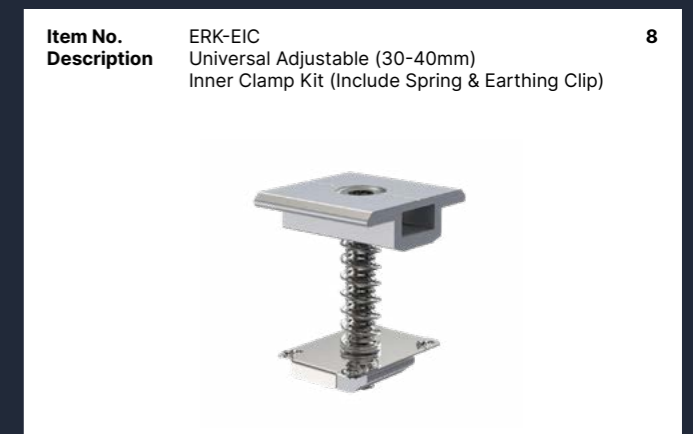
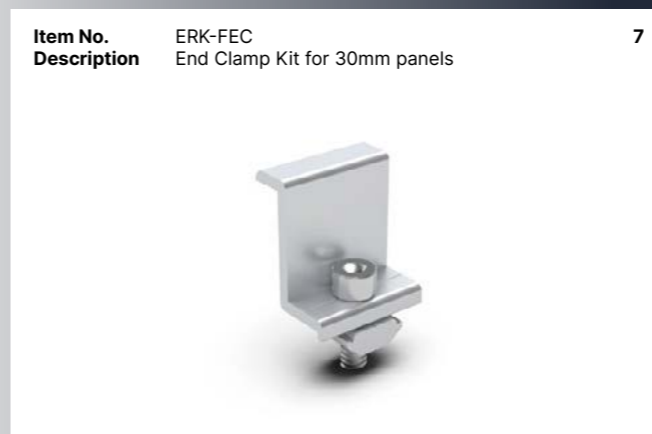
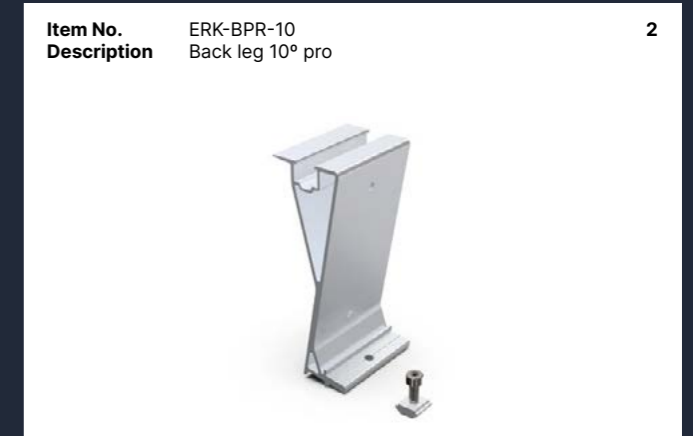

BALLASTED-ULT MOUNTING

Mountkit East & West Ballasted-Ult Systems are designed for use on concrete flat roofs and trapezoidal sheet metal roofs.

Unlike traditional solar panel mounting methods that fix panels at the ends of their long sides, this series allows for attachment anywhere along the long side. This feature enables solar panels to withstand greater wind and snow pressure.

There is no need for expansion bolts or chemical bolts, ensuring no damage to the roof.

The system connects all panels with rails, creating a unified structure.

East-west facing panels are highly effective in resisting wind loads.

The use of high-quality aluminum components ensures a robust, reliable system that is quick and easy to install.

The same components can be utilized for a south-facing flat roof installation.

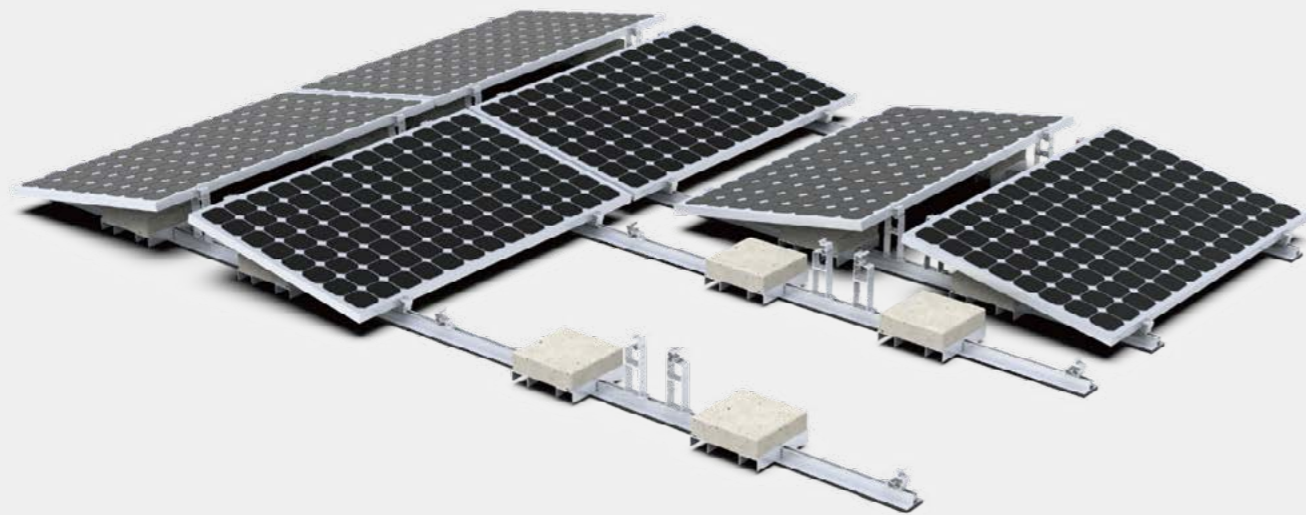

TECHNICAL FEATURES	
Product name	Ballasted-ULT Series
Application	Concrete flat roof and trapezoidal sheet metal roof
Tilt	10°
System Material	Extruded aluminum profile 6005 T5, EPDM
Fastener material	Stainelss steel 304
Finish	Anodized
Module orientation	Landscape



RAIL & ACCESSORIES

According to different markets, different customer requirements, as well as the project budget, we design and produce various types of rails and accessories to meet the customer's projects need. Each product is subjected to rigorous strength calculation, SGS testing, TUV, CE, and AS/NZS1170.2 certifications.

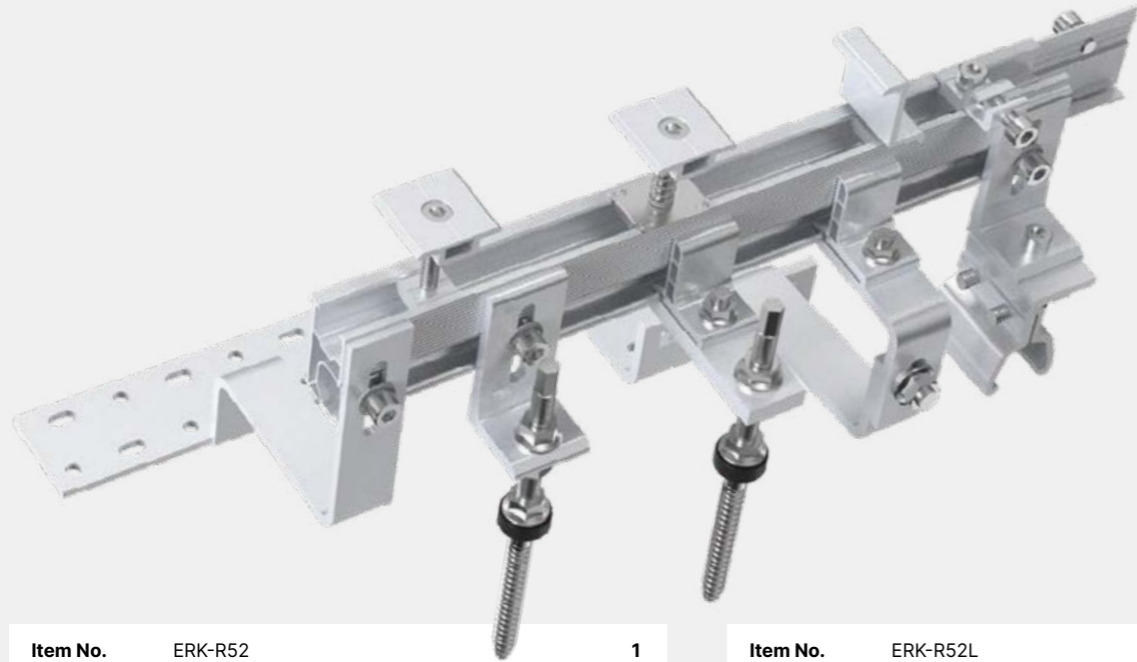

Item No. ERK-R52
Description 52mm Rail 1



Item No. ERK-R52L
Description 52mm L Rail 2



Item No. ERK-SFR-01
Description Splice for Rail Kit 01 3



Item No. ERK-REC-B
Description Rail End Cover Cap EPDM rubber 4



Item No. ERK-TEC
Description Thin Film Double-glazed Module End Clamp Kit 1



Item No. ERK-TIC
Description Thin Film Double-glazed Module Inner Clamp Kit 2



Item No. ERK-AIC
Description Universal Adjustable (30-40mm) Inner Clamp Kit 3



Item No. ERK-EIC
Description Universal Adjustable (30-40mm) Inner Clamp Kit (Include Spring & Earthing Clip) 4



Item No. ERK-AEC
Description Universal Adjustable (30-35mm) End Clamp Kit 5



Item No. ERK-FEC
Description End Clamp Kit for 30mm panels 6



Item No. ERK-ELG-02
Description Earthing Lug Kit 02 7



Item No. ERK-NBW
Description ERK Nuts Assembly with Bolt and Washer Kit 8



Item No. ERK-CCP-04
Description Cable Clip for PV Panels for holding 2 Cables 9



Item No. ERK-CCP-05
Description Cable Clip for PV Panels for holding 4 Cables 10

